

LiveAction



LiveWire PowerCore 3300

Quick Start Guide

LiveAction, Inc.
901 Campisi Way, Ste. 222
Campbell, CA 95008, USA
+1 (888) 881-1116
<https://www.liveaction.com>

Copyright © 2024 LiveAction, Inc.
All rights reserved

20241029-PC3300_2430a

Contents

LiveWire PowerCore 3300	1
About LiveWire PowerCore 3300.....	1
What's included	1
LiveWire PowerCore 3300 Technical Specifications	1
LiveWire PowerCore 3300 front / back panels	4
Front panel	4
Back panel.....	5
Inside the LiveWire PowerCore 3300.....	6
Internal components	7
Installing LiveWire PowerCore 3300.....	8
Connecting network cables.....	9
System fans.....	9
Connecting TeraVault to LiveWire PowerCore 3300	9
Connecting multiple TeraVault units	12
LiveWire PowerCore 3300 activation.....	13
Activation via Omnippeek Web	14
Activation via Omnippeek	17
Starting / shutting down LiveWire PowerCore 3300	21
Attaching the front bezel	22
Contacting LiveAction support	22

LiveWire PowerCore 3300

About LiveWire PowerCore 3300

Congratulations on your purchase of LiveWire™ PowerCore 3300! The LiveWire PowerCore 3300 appliance uniquely combines flow-based reporting using deep packet inspection (DPI) with high-speed, packet capture and storage. LiveWire PowerCore 3300 is designed to work with LiveAction's LiveNX and various other platforms. Because LiveWire PowerCore 3300 starts with packet data, it is able to provide a unique, and extended, set of flow-based monitoring data called LiveFlow. LiveFlow is extended IPFIX data and is exported to LiveNX and other platforms. Please also refer to the LiveNX and the other platform documentation for more information on using the LiveFlow data exported to LiveNX and other platforms.

What's included

Your standard LiveWire PowerCore 3300 package includes:

- LiveWire packet capture and analysis appliance
- Pre-loaded, tested, and fully integrated LiveWire software for high-speed packet capture, storage, and flow based telemetry generation
- Web-based configuration
- LiveWire Omnipeek
- Omnipeek for Windows License (1)
- Two power cords
- Rack-mount rails
- Chassis bezel

LiveWire PowerCore 3300 Technical Specifications

Specification	Description
Base	OEM Dell PowerEdge R7615 Server
Chassis	Chassis with up to 12 x 3.5" HDDs
Motherboard	OEM PowerEdge R7615 Motherboard
Processor	AMD EPYC 9354P 3.25 GHz, 32C/64T
Memory	256 GB or RAM 32GB RDIMM, 4800MT/s, Dual Rank (8)
RAID/Internal Storage Controllers	PERC H755 Adapter, Low Profile
Hard Drive	960 GB BOSS M.2 Drives (2) 20 TB Hard Drive SAS 12 Gbps 7.2 K 512e 3.5 in Hot-Plug (12)
Network Adapters	Broadcom 5720 Dual Port 1Gbe LOM Broadcom 57416 Dual Port 10GbE BASE-T Adapter, OCP NIC 3.0

Specification	Description
Fans	Performance Fans (6)
Power Supply	Dual, Hot-Plug, Power Supply, 2400W MM (100-240 Vac), Redundant (1+1)
Power Cords	C13, 3 M, 125 V, 15 A (2)
PCIe Riser	Riser Config 3 - 2 x 16 FH (Gen5) - 2 x 8 FH - 2 x 16 LP, Half Length
Embedded Systems Management	iDRAC9, Enterprise
Quick Sync	None
Rack Rails	ReadyRails Sliding Rails Without Cable Management Arm
PSU Specifications:	
PSU	2400 W mixed mode
Class	Platinum
Heat Dissipation (Maximum)	9000
Frequency	50/60
Voltage	2400 W
High Line 200 V 240 V	1400
Low Line 100-140 V	N/A
Current	N/A
Temperature Specifications ASHRAE A2:	
Allowable continuous operations	
Temperature range for altitudes < = 900 m (< = 2953 ft)	10–35°C (50–95°F) with no direct sunlight on the equipment
Humidity percent range (non-condensing at all times)	8% RH with -12°C minimum dew point to 80% RH with 21°C (69.8°F) maximum dew point
Operational altitude de-rating	Maximum temperature is reduced by 1°C/300 m (1.8°F/984 Ft) above 900 m (2953 Ft)
Temperature Specifications ASHRAE A3:	
Allowable continuous operations	
Temperature range for altitudes < = 900 m (< = 2953 ft)	5–40°C (41–104°F) with no direct sunlight on the equipment
Humidity percent range (non-condensing at all times)	8% RH with -12°C minimum dew point to 85% RH with 24°C (75.2°F) maximum dew point
Operational altitude de-rating	Maximum temperature is reduced by 1°C/175 m (1.8°F/574 Ft) above 900 m (2953 Ft)
Temperature Specifications ASHRAE A4:	
Allowable continuous operations	
Temperature range for altitudes < = 900 m (< = 2953 ft)	5–45°C (41–113°F) with no direct sunlight on the equipment
Humidity percent range (non-condensing at all times)	8% RH with -12°C minimum dew point to 90% RH with 24°C (75.2°F) maximum dew point
Operational altitude de-rating	Maximum temperature is reduced by 1°C/125 m (1.8°F/410 Ft) above 900 m (2953 Ft)
Relative Humidity Specifications:	

Specification	Description
Operating	10% to 80% relative humidity with 29°C (84.2°F) maximum dew point.
Storage	8% RH with -12°C minimum dew point to 90% RH with 24°C (75.2°F) maximum dew point. Non-condensing at all times.
Maximum Vibration Specifications:	
Operating	0.21 G _{rms} at 5 Hz to 500 Hz for 10 minutes (all operation orientations)
Storage	1.88 G _{rms} at 10 Hz to 500 Hz for 15 minutes (all six sides tested)
Maximum Shock Pulse Specifications:	
Operating	Six consecutively executed shock pulses in the positive and negative x, y, and z axis of 6 G for up to 11 ms
Storage	Six consecutively executed shock pulses in the positive and negative x, y, and z axis (one pulse on each side of the system) of 71 G for up to 2 ms

LiveWire PowerCore 3300 front / back panels

See the illustrations and descriptions of the LiveWire PowerCore 3300 front and back panel in the sections below.





Front panel



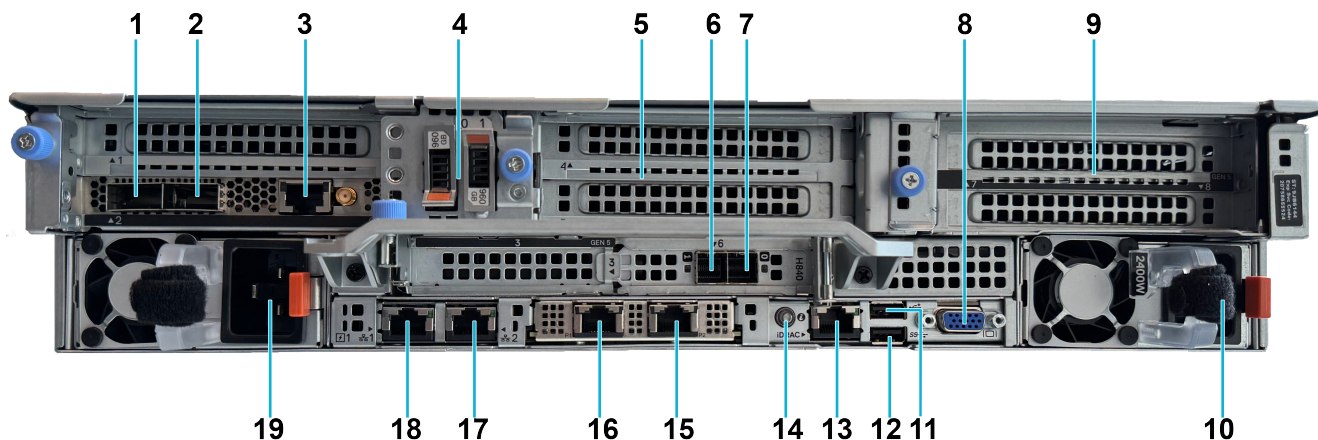

Item	Ports, Panels, or Slots	Icon	Description
1	Left control panel	N/A	Contains the system health, system ID, and the status LED indicator.
2	Drives	N/A	Enables you to install drives that are supported on your system.
3	Right control panel	N/A	Contains the power button with integrated power LED, 1 x VGA port, 1 x 2.0 USB port, iDRAC Direct (Micro-AB USB) port, and the iDRAC Direct status LED.
4	Information tag	N/A	The Express Service Tag is a slide-out label panel that contains system information such as Service Tag, NIC, MAC address, and so on. If you have opted for the secure default access to iDRAC, the Information tag will also contain the iDRAC secure default password.

Back panel



Item	Ports, Panels, or Slots	Icon	Description
1	Port 0	N/A	QSFP28 network port
2	Port 1	N/A	QSFP28 network port
3	RJ45-F 1000BASE-T IEEE1588 PTP	N/A	External RJ45 time synchronization connector
4	BOSS module	N/A	BOSS-N1 module
5	PCIe expansion card riser 3 (slot 5)	N/A	The expansion card riser enables you to connect PCI Express expansion cards. For more information, see the Expansion card installation guidelines section.
6	Port B/1	N/A	Mini-SAS HD external SFF8644 port on the RAID card. The SAS external cascading cable that connects the TeraVault JBOD storage unit to the RAID card on LiveWire PowerCore 3300 is plugged into this port. Make sure the blue pull tab on the cable is on the bottom when plugging into this port.
7	Port A/0	N/A	Mini-SAS HD external SFF8644 port on the RAID card.
8	VGA port	N/A	Enables you to connect a display device to the system.
9	PCIe expansion card riser 4 (slot 7)	N/A	The expansion card riser enables you to connect PCI Express expansion cards. For more information, see the Expansion card installation guidelines section.
10	Power supply unit (PSU2)		PSU2 is the secondary PSU of the system.
11	USB 2.0 port		The USB port is 4-pin, 2.0-compliant. This port enables you to connect USB devices to the system.
12	USB 3.0 port		The USB port is 9-pin and 3.0-compliant. This port enables you to connect USB devices to the system.
13	Dedicated iDRAC9 Ethernet port		Enables you to remotely access iDRAC. For more information, see the Integrated Dell Remote Access Controller User's Guide at PowerEdge Manuals.

Item	Ports, Panels, or Slots	Icon	Description
14	System Identification (ID) button		<p>The System Identification (ID) button is available on the front and back of the system. Press the button to identify a system in a rack by turning on the system ID button. You can also use the system ID button to reset iDRAC and to access BIOS using the step through mode. When pressed, the system ID LED in the back panel blinks until either the front or rear button is pressed again. Press the button to toggle between on or off mode.</p> <p>NOTE: If the server stops responding during POST, press and hold the System ID button for more than five seconds to enter the BIOS progress mode</p> <p>NOTE: To reset the iDRAC (if not disabled on the iDRAC setup page by pressing F2 during system boot), press and hold the System ID button for more than 15 seconds.</p>
15	NIC Port (eth3)	N/A	The NIC port is integrated on the OCP card which is connected to the system board.
16	NIC Port (eth2)	N/A	The NIC port is integrated on the OCP card which is connected to the system board.
17	NIC Port (eth1)	N/A	The NIC port is embedded on the LOM card that is connected to the system board.
18	NIC Port (eth0)	N/A	The NIC port is embedded on the LOM card that is connected to the system board.
19	Power supply unit (PSU1)	 1	PSU1 is the primary PSU of the system.

Inside the LiveWire PowerCore 3300

CAUTION! Many repairs may only be done by a certified service technician. You should only perform troubleshooting and simple repairs as directed by the LiveAction support team. Damage due to servicing that is not authorized by LiveAction is not covered by your warranty. Read and follow the safety instructions that are shipped with your product.

Note A defective drive should have a consistent RED blinking LED which should make it easier to detect.

Internal components

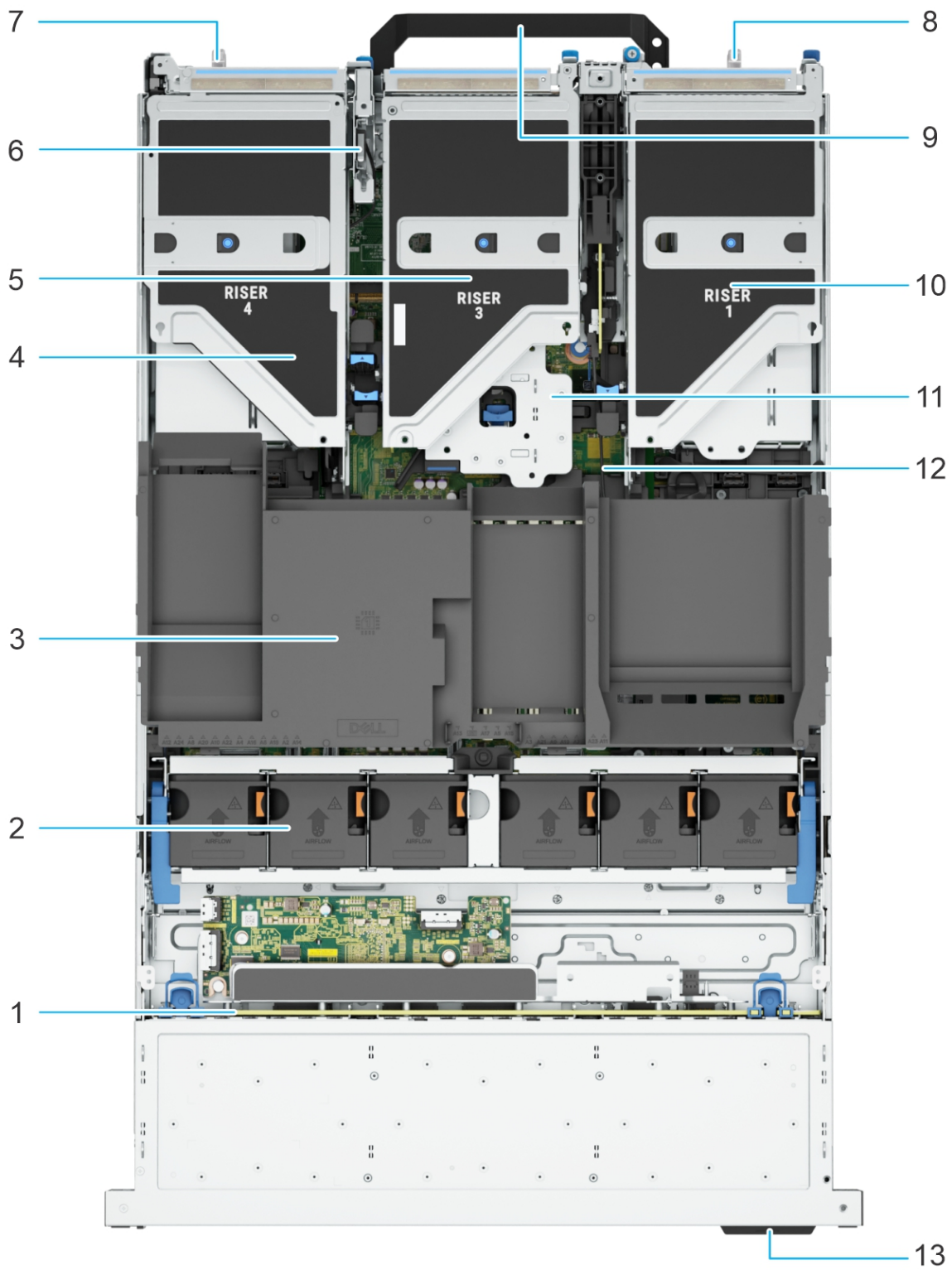

Item	Description
1	Drive backplane
2	Cooling fan cage assembly
3	Air shroud top cover
4	Riser 4
5	Riser 3
6	Intrusion switch
7	Power Supply Unit (PSU 1)
8	Power Supply Unit (PSU 2)
9	Handle
10	Riser 1
11	Riser 2
12	System board
13	Information tage

Note A defective drive should have a consistent RED blinking LED which should make it easier to detect.

Installing LiveWire PowerCore 3300



LiveWire PowerCore 3300 with front bezel attached

To install LiveWire PowerCore 3300:

1. Place LiveWire PowerCore 3300 on a flat surface, or mount it in a standard 19-inch equipment rack.
2. Connect a power cable to each of the two power outlets at back of the unit.

Note LiveWire PowerCore 3300 has two redundant high-efficiency “hot-swappable” power supplies. If a power module fails, it should be replaced immediately. If your LiveWire PowerCore 3300 is under warranty, please contact Technical Support to arrange for a replacement power supply.

3. Plug the other end of the power cables to an AC outlet.

Important! WARNING: This device has more than one power cord. Disconnect ALL power supply cords before servicing.

AVERTISSEMENT: Cet appareil a plus d'une cordon d'alimentation. Débranchez TOUTES les cordons d'alimentation avant l'entretien.

Connecting network cables

LiveWire PowerCore 3300 includes Gigabit Ethernet ports and Integrated Remote Access Controller (iDRAC) ports used for remotely accessing and troubleshooting LiveWire PowerCore 3300. See 'LiveWire PowerCore 3300 front / back panels' on page 4 for the location of these ports.

To connect network cables:

- Use a standard Ethernet cable to connect these ports to your network.

Tip To reach LiveWire PowerCore 3300 through an SSH connection, you can use an Ethernet cable connected directly between the Gigabit Ethernet port on LiveWire PowerCore 3300 and your PC or laptop. LiveWire PowerCore 3300 eth0 port is configured at the factory to have a DHCP IP address with a fail over to 192.168.1.21. The PC or laptop must be configured to be on the same IP subnet.

System fans

LiveWire PowerCore 3300 has multiple cooling fans that are used to cool the system chassis. If any one of the fans fail, it should be replaced immediately. If your LiveWire PowerCore 3300 is under warranty, please contact LiveAction Technical Support to arrange for a replacement fan.

Important! The chassis top cover must be properly installed in order for the cooling air to circulate correctly through the chassis and cool the components.

Important! WARNING: Slide/rail mounted equipment is not to be used as a shelf or a work space.

AVERTISSEMENT: Le matériel monté sur rails/coulisseaux ne doit pas être utilisé comme étagère ou espace de travail.

Connecting TeraVault to LiveWire PowerCore 3300

The storage capacity of any LiveWire PowerCore 3300 with 200 TB, RAID 6 (240 TB, optional RAID 0) of total hard disk capacity can be increased through the addition of TeraVault for LiveWire PowerCore. TeraVault is available in a configuration of 200 TB, RAID 6 (240 TB, optional RAID 0). Up to four TeraVault units can be added for a total of up to 1000 TB, RAID 6 (1200 TB, optional RAID 0). If you purchased TeraVault with your LiveWire PowerCore 3300, the instructions to connect it to your LiveWire PowerCore 3300 are provided below.

To connect TeraVault to LiveWire PowerCore 3300:

1. Make sure both TeraVault and LiveWire PowerCore 3300 are powered OFF.
2. Select a suitable location for both TeraVault and LiveWire PowerCore 3300. Both units can be installed on a flat surface, or mounted in a standard 19-inch equipment rack.
3. Run the SAS external cascading cable between the units so that the cable is not kinked, bent, or twisted. The SAS external cascading cable is included with TeraVault.

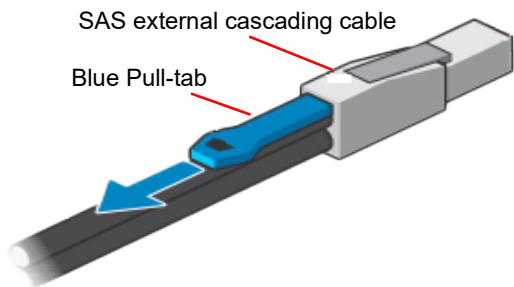

Note If you have multiple TeraVault boxes, and the system is disconnected for any reason, the cabling of the boxes needs to be exactly as it was before, otherwise the RAID won't be seen correctly. To assist you with the cabling, every TeraVault box is labeled with a number, and every TeraVault cable is labeled to the exact port it needs to get plugged into. See 'Connecting multiple TeraVault units' on page 12.

4. Facing the rear of LiveWire PowerCore, insert one connector of the SAS external cascading cable into the left RAID port (Port B/1) of the RAID controller on LiveWire PowerCore 3300 so that the release blue pull-tab is on the bottom as shown below.

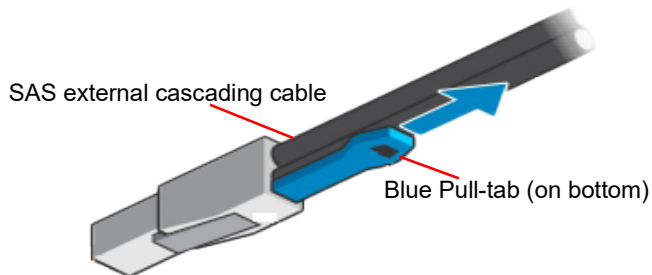
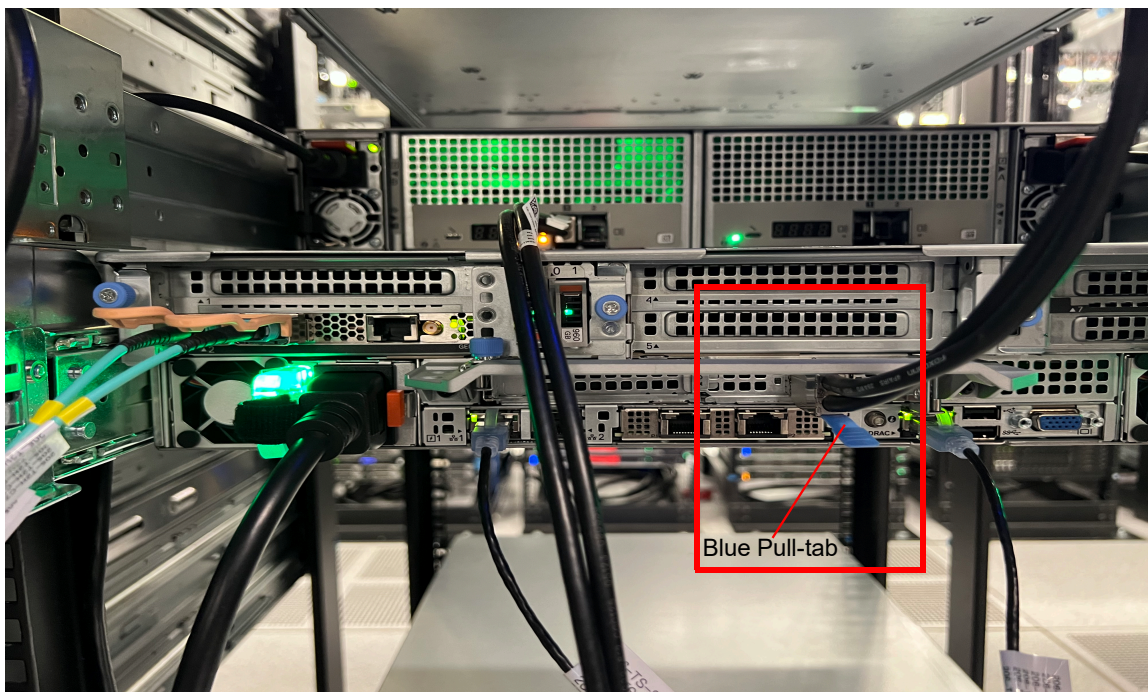

Cable orientation when connected to PowerCore 3300 RAID card

Note It may be necessary to remove the handle on the rear of the appliance in order to connect the SAS external cascading cable into the left RAID port (Port B/1) of the RAID controller.

5. Facing the rear of TeraVault, insert the other end of the SAS external cascading cable into Port 0 on the TeraVault so that the release pull-tab is on the top.

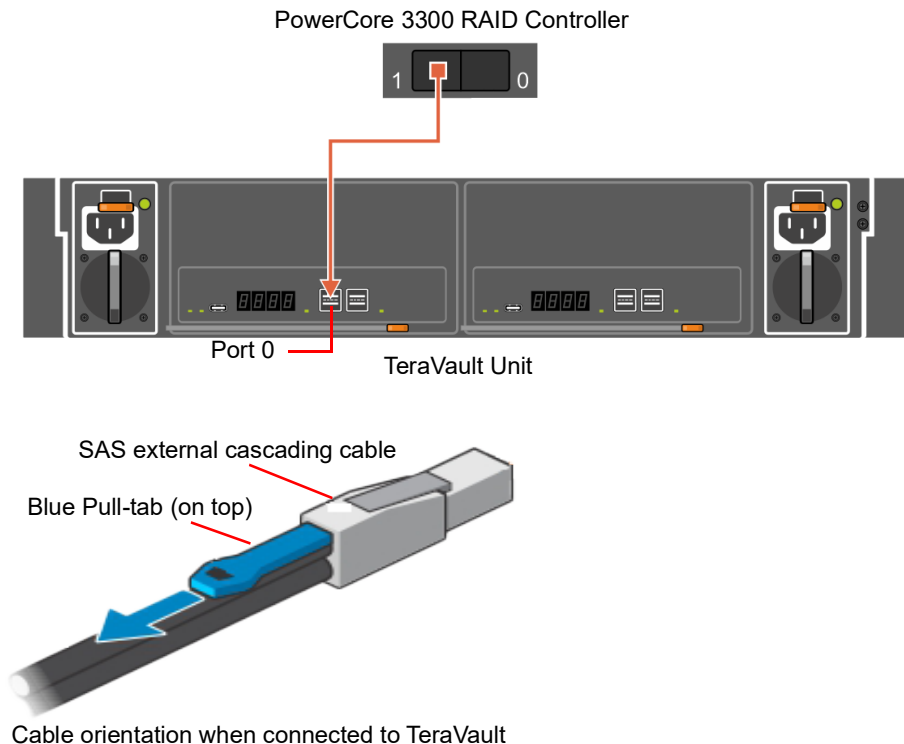

Note Be certain the connectors are installed completely as it can look and feel as if the cable is secured without actually making a connection. Give the connector body a tug, then push it in again to be sure.

6. To set up a configuration with redundant paths, both ports on the LiveWire PowerCore 3300 RAID card must be cabled to the two ports of a single TeraVault unit as shown below. You will essentially repeat steps 1 - 5 above, but this time you will be connecting both ports on the TeraVault unit 'JBOD 1' to both ports on the LiveWire PowerCore 3300 RAID card (H840) as shown below.

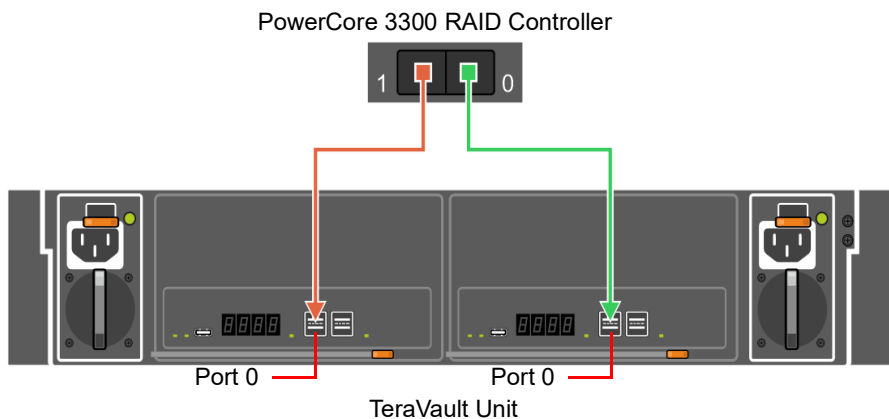

7. Turn on power to TeraVault by simply plugging the power cable into a power supply. The TeraVault must be powered on first (order matters). You may see brief bursts of LED activity as the expander in TeraVault scans the drives.
8. Turn on the power to LiveWire PowerCore. The system is ready for use as soon as the LiveWire PowerCore boot sequence completes.

Connecting multiple TeraVault units

When connecting multiple TeraVault (JBOD) units to LiveWire PowerCore 3300, it is important to note that each LiveWire PowerCore 3300 and TeraVault unit have LiveAction labels with matching serial numbers. Additionally, each TeraVault unit has a label on the front (designating JBOD 1, 2, 3, etc.), which is the order the units are daisy-chained to LiveWire PowerCore 3300 and each of the TeraVault units. Multiple SAS external cascading cables are included and are also labeled to guide you in connecting each of the units.

To connect multiple TeraVault units:

1. Locate the LiveAction label on each LiveWire PowerCore 3300 and TeraVault unit. Make sure the LiveAction serial numbers are the same on LiveWire PowerCore 3300 and each of the storage units.
2. Locate the first TeraVault unit labeled as 'JBOD 1' and also the SAS external cascading cable labeled 'HBA - Port 0.' Use the 'HBA - Port 0' cable and connect the TeraVault unit 'JBOD 1' to LiveWire PowerCore 3300 as described in 'Connecting TeraVault to LiveWire PowerCore 3300' on page 9. **Make sure the blue release pull-tab on the cable connected to the LiveWire PowerCore 3300 RAID card is on the bottom, while the pull-tab connected to the TeraVault JBOD is on the top.**
3. Locate the second TeraVault unit labeled as 'JBOD 2' and also the SAS external cascading cable labeled 'JBOD 1 - Port 1.' Use the 'JBOD 1 - Port 1' cable and connect this TeraVault unit to the previous TeraVault unit (JBOD 1). Make sure the release pull-tab on the cable is on the top.
4. Repeat Step 3 for any additional TeraVault units, making sure each successive 'JBOD' is connected to the previous 'JBOD' using the appropriate SAS external cascading cable.
5. To set up a configuration with redundant paths, both ports on the LiveWire PowerCore 3300 RAID card must be cabled to the ports of a single TeraVault unit as shown below. You will essentially repeat steps 1 - 4 above, but this time you will be connecting both ports on the TeraVault unit 'JBOD 1' to both ports on the LiveWire PowerCore 3300 RAID card.

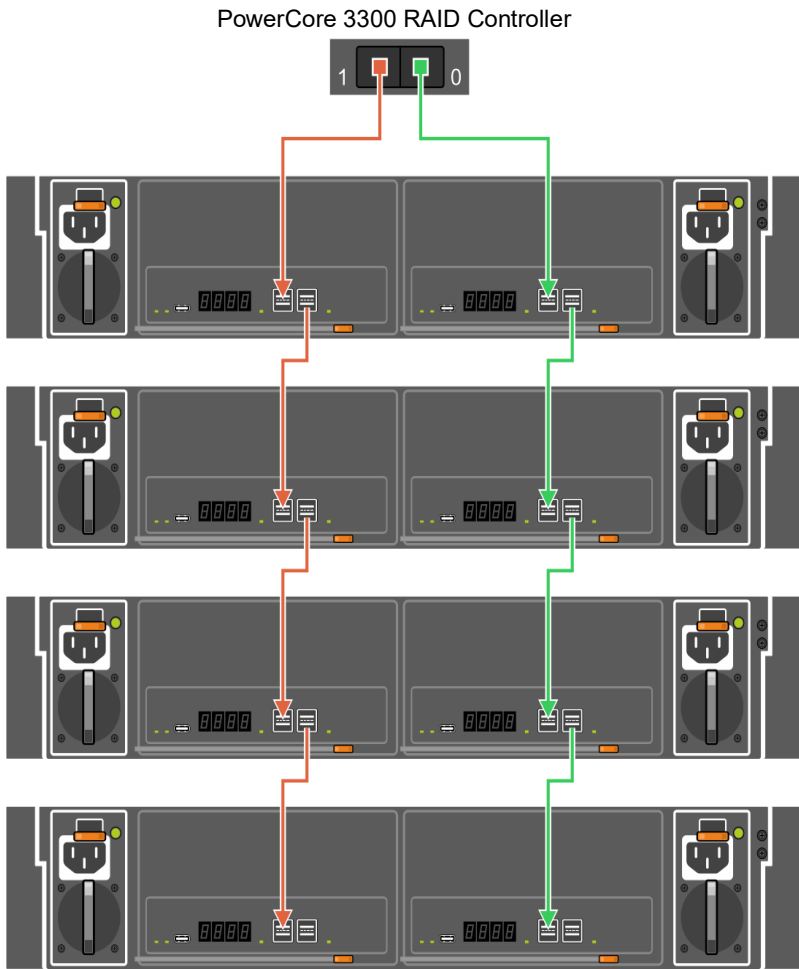

LiveWire PowerCore 3300 activation

Once LiveWire is installed, when you attempt to connect to it for the very first time, you must activate the product before it can be used. You can activate LiveWire either from logging directly into a web-based version of OmnipEEK, or from the **Capture Engines Window** in OmnipEEK.

Both an automatic and a manual method are available for activation. The automatic method is quick and useful if you have Internet access from the computer from where you are performing the activation. If Internet access is not available, the manual method is available; however, you will need to go to a computer that does have Internet access in order to download a License file that is required to complete the manual activation.

You will need to enter the following information to successfully activate LiveWire, so please have this information readily available:

- IP address of LiveWire
- Product key
- User name
- Company name
- Email address
- Version number

Activation via Omnipeek Web

To activate LiveWire via Omnipeek:

1. From your web browser, type the IP address of LiveWire into the URL field of the browser and press **Enter**. The Omnipeek login screen appears.

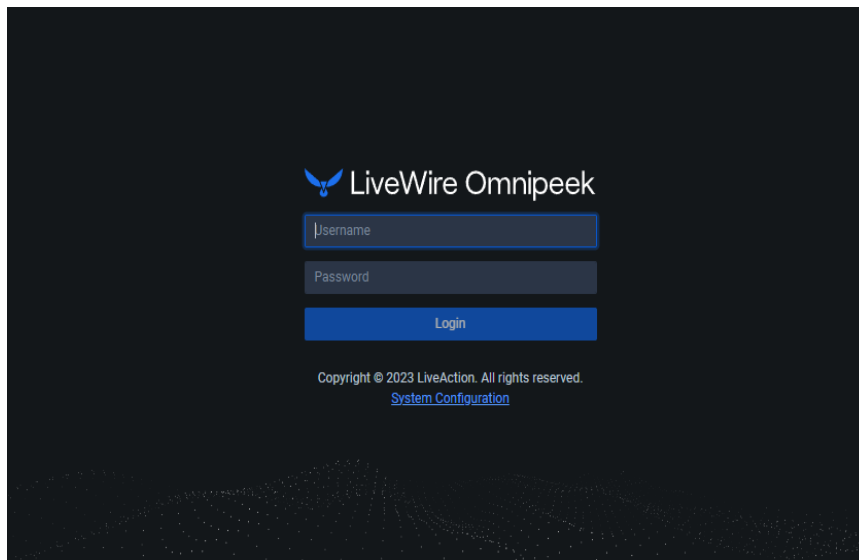

- *Username*: Type the username for LiveWire. The default is *admin*.
 - *Password*: Type the password for LiveWire. The default is *admin*.
2. Type the *Username* and *Password* and click **Login**. The Omnipeek *Activation License* window appears.

Note You can also access the *Omnipeek Activation License* window by clicking *Update License* from the Capture Engine *Home* screen in Omnipeek.

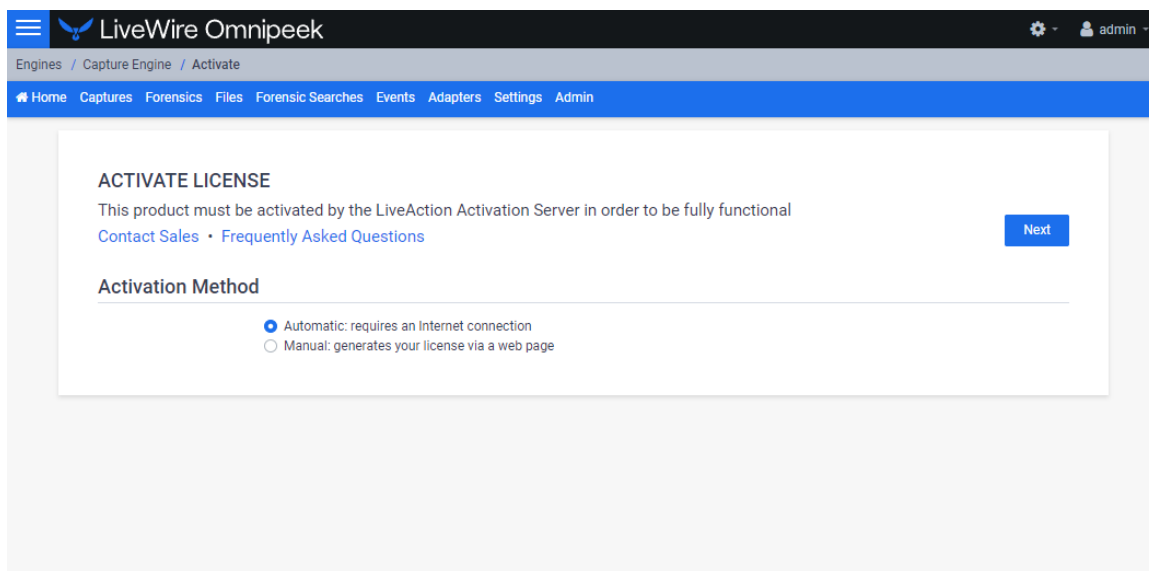

3. If your client has an active Internet connection, select *Automatic* and click **Next**. The **Customer Information** window appears. Continue with Step 4 below.

ACTIVATE LICENSE
This product must be activated by the LiveAction Activation Server in order to be fully functional
[Contact Sales](#) • [Frequently Asked Questions](#) Previous Next

Customer Information

NAME

COMPANY

EMAIL

PRODUCT KEY

Device serial number: 785Y4Z2

- *NAME*: Type the user name of the customer.
- *COMPANY*: Type the company name.
- *EMAIL*: Type the email address of the customer.
- *PRODUCT KEY*: Type the product key.

If your client does not have an active Internet connection, or you are prevented from accessing the Internet using personal firewalls, or there are other network restrictions that may block automatic activations, select *Manual* and click **Next**. The **Manual Activation** window appears. Skip to Step 5 below.

Note The manual activation method is available for instances described above; however, you will need to go to a computer that does have Internet access in order to download a License file that is required to complete the manual activation.

ACTIVATE LICENSE
This product must be activated by the LiveAction Activation Server in order to be fully functional
[Contact Sales](#) • [Frequently Asked Questions](#) Previous Next

Manual Activation

Follow this link to [activate](#) and fill out the form there.

You will need the following information:
Locking code: *1ZZVVZ8W95UM5LD

When you are finished and have a license file, enter the Product Key, click Choose License File below and then click Next.

PRODUCT KEY

Device serial number: 785Y4Z2

LICENSE FILE

Note The *Locking code* displayed in the window above is required in Step 6 below. You can click the small icon next to the code to save it to the clipboard so you can paste it into the Locking Code field in Step 6 below.

4. Complete the Customer Information window and click **Next**. LiveWire is now activated and you can begin using the product. The activation process is complete.

Note If the automatic activation does not complete successfully, go back and select the manual activation process. Personal firewalls or other network restrictions may block automatic activations.

5. Click the *activate* link (https://mypeek.liveaction.com/activate_product.php) in the window. A web browser page opens that allows you to activate your LiveAction product and to obtain and download a license file. The license file is required to complete the manual activation.

Activate Your LiveAction Product

Use this form to activate LiveAction software in instances where the machine you are installing on doesn't have an internet connection.

PLEASE NOTE: This form is only used to activate version 12.0 and later of our Omnippeek and Capture Engine products. If you have a version previous to 12.0, please go to <https://reg.savvius.com> to manually activate your product.

Version:	<input type="text" value="--"/> <input type="text" value="--"/>	Enter only two numbers, e.g. for 3.0.1, enter 3.0.
Product Key or Serial Number :	<input type="text"/>	
Locking Code:	<input type="text"/>	During installation of your product, this value will be displayed on your screen. Please enter it exactly as shown.
First Name:	<input type="text"/>	
Last Name:	<input type="text"/>	
Email Address:	<input type="text"/>	
Company:	<input type="text"/>	
<input type="button" value="ACTIVATE PRODUCT ▶"/>		

6. Complete the information on the activation page and click **ACTIVATE PRODUCT**. The following page appears once the activation is complete.

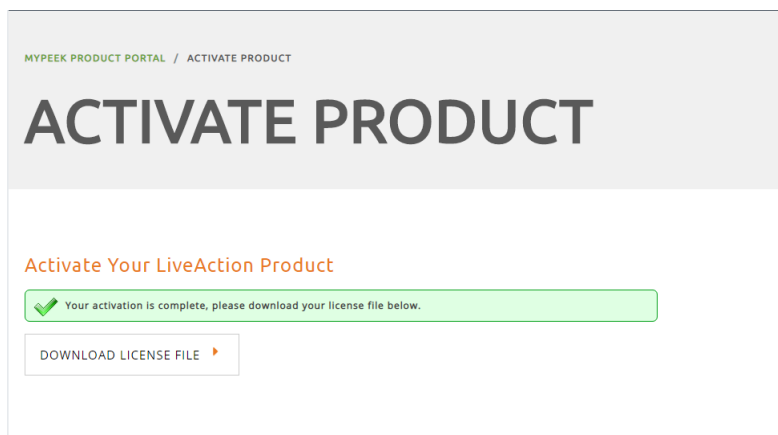

7. Click **DOWNLOAD LICENSE FILE** to save the license file to your computer. You will need the license file in the following steps.
8. Return back to the to the **Manual Activation** window, and click **Choose License File**.
9. Navigate to the license file downloaded above and click **Open**.
10. Click **Next** in the **Manual Activation** window. LiveWire is now activated and you can begin using the product. The activation process is complete.

Activation via Omnipeek

Note Activation of LiveWire via Omnipeek is supported on Omnipeek version 13.1 or higher.

To activate LiveWire via Omnipeek:

1. From the Omnipeek Start Page, click **View Capture Engines** to display the **Capture Engines** window.

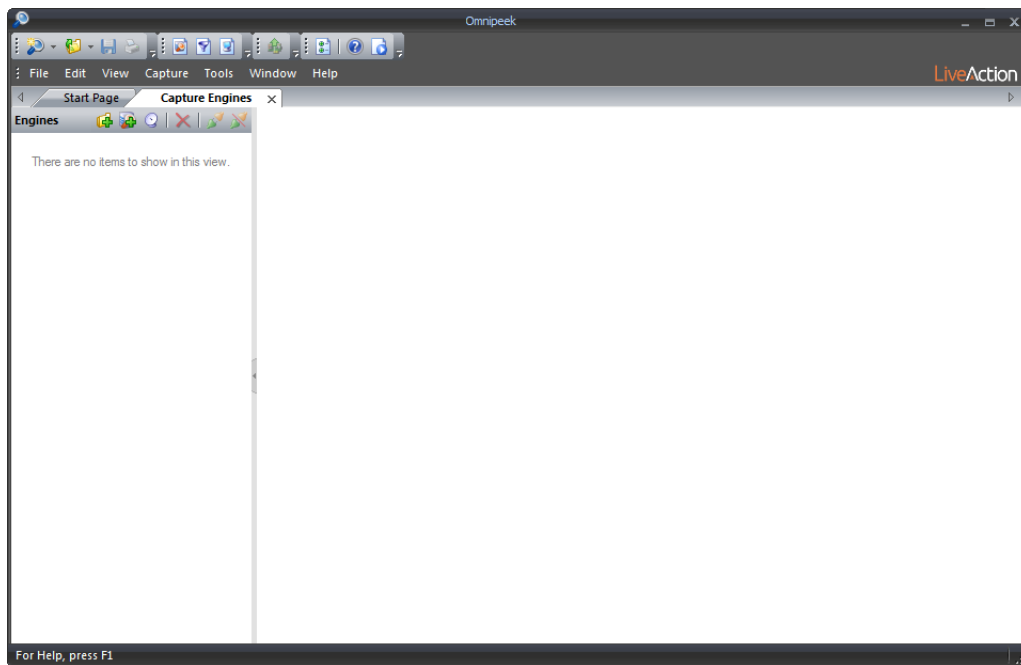

2. Click *Insert Engine* and complete the **Insert Engine** dialog.

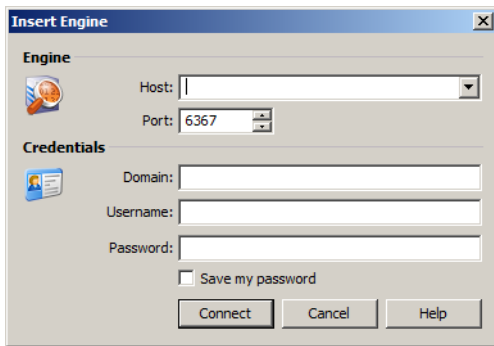

- *Host*: Enter the IP address of LiveWire.
 - *Port*: Enter the TCP/IP port used for communications. Port 6367 is the default for LiveWire.
 - *Domain*: Type the Domain for login to LiveWire. If LiveWire is not a member of any Domain, leave this field blank.
 - *Username*: Type the username for LiveWire. The default is *admin*.
 - *Password*: Type the password for LiveWire. The default is *admin*.
 - *Save my password*: Select this option to remember your password to connect to LiveWire.
3. Click **Connect** to connect to LiveWire. If LiveWire has not yet been activated, the activation message appears in the **Capture Engines** window.

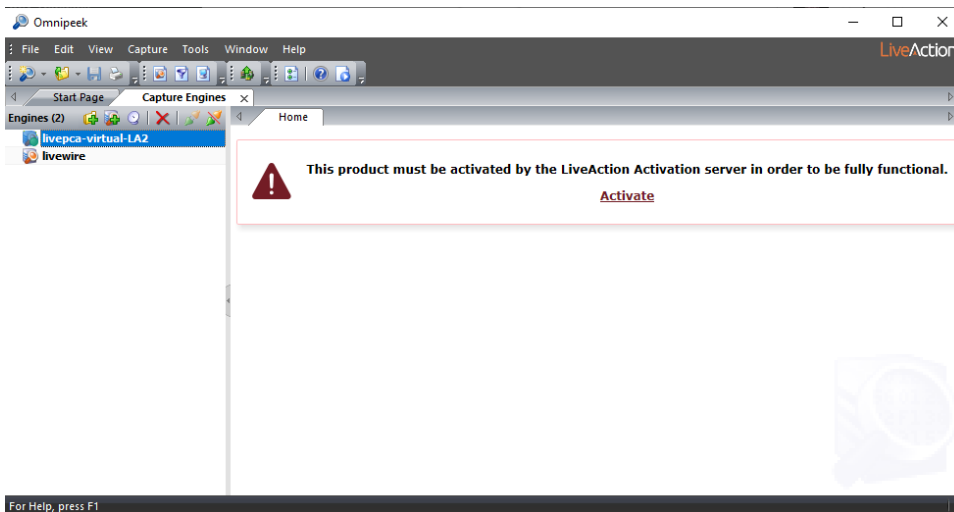

4. Click *Activate LiveWire*. The **Activation Method** dialog appears.

Product Activation

Activation Method
Choose Automatic or Manual Activation

This product must be activated by the LiveAction Activation server in order to be fully functional. For more information, go to [Frequently Asked Questions](#).

Automatic: requires an Internet connection
 Manual: generates your license via a web page

< Back Next > Cancel

5. If your client has an active Internet connection, select *Automatic* and click **Next**. Otherwise, select *Manual* and click **Next**. The **Customer Information** dialog appears.

Product Activation

Customer Information
Enter the following information

Please enter the following

User Name:

Company Name:

Email:

Serial Number or Product Key:

< Back Next > Cancel

- *User Name*: Type the user name of the customer.
- *Company Name*: Type the company name.
- *Email*: Type the email address of the customer.
- *Serial Number or Product Key*: Type either the serial number or product key.

6. Complete the **Customer Information** dialog and click **Next**. If you selected the *Automatic* activation, LiveWire is now activated and you can begin using the product. The activation process is complete.

If you selected the *Manual* activation, the **Manual Activation** dialog appears. You will need to continue with the remaining steps.

Note The manual activation method is available for instances when a computer does not have Internet access; however, you will need to go to a computer that does have Internet access in order to download a License file that is required to complete the manual activation.

Note The *Product Key*, and also the *Locking Code* displayed in the **Manual Activation** dialog are required in the next step. You can cut and paste this information from the **Manual Activation** dialog when required in the next step.

- Click the *activate product* link (https://mypeek.liveaction.com/activate_product.php) in the dialog. A web browser page opens that allows you to activate your LiveAction product and to obtain and download a license file. The license file is required to complete the manual activation.

Activate Your LiveAction Product

Use this form to activate LiveAction software in instances where the machine you are installing on doesn't have an internet connection.

PLEASE NOTE: This form is only used to activate version 12.0 and later of our Omnippeek and Capture Engine products. If you have a version previous to 12.0, please go to <https://reg.savvius.com> to manually activate your product.

Version:	<input type="text" value="--"/> . <input type="text" value="--"/>	Enter only two numbers, e.g. for 3.0.1, enter 3.0.
Product Key or Serial Number :	<input type="text"/>	
Locking Code:	<input type="text"/>	During installation of your product, this value will be displayed on your screen. Please enter it exactly as shown.
First Name:	<input type="text"/>	
Last Name:	<input type="text"/>	
Email Address:	<input type="text"/>	
Company:	<input type="text"/>	
<input type="button" value="ACTIVATE PRODUCT ▶"/>		

- Complete the information on the activation page and click **ACTIVATE PRODUCT**. The following page appears once the activation is complete.

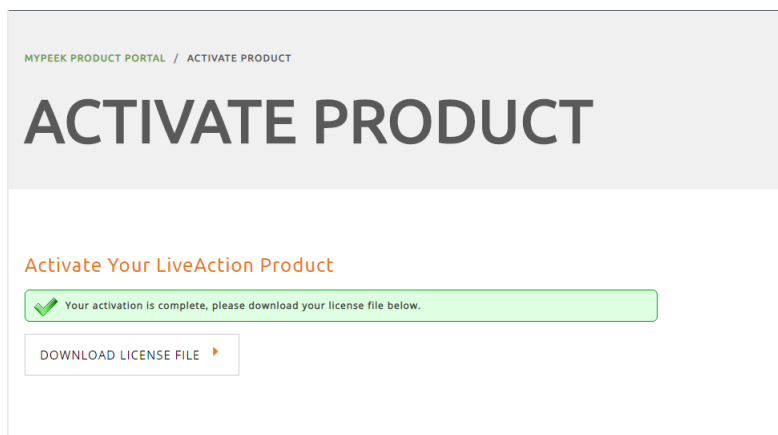

9. Click **DOWNLOAD LICENSE FILE** to save the license file to your computer. You will need the license file in Step 11 below.
10. Return to the **Omnipeek Product Activation** dialog, and click **Next**. The **Manual Activation/Choose the license file** dialog appears.

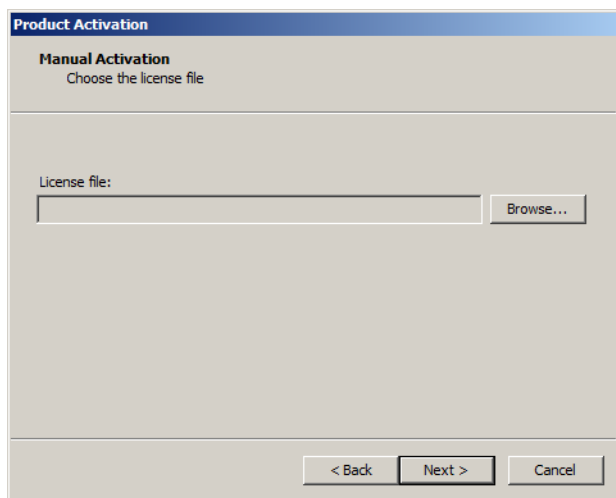

11. Browse to the license file that was downloaded above and click **Next**. LiveWire is now activated and you can begin using the product. The activation process is complete.

Starting / shutting down LiveWire PowerCore 3300

To start LiveWire PowerCore 3300:

- LiveWire PowerCore: Press the power button in the upper right corner on the front of the chassis.

To shutdown LiveWire PowerCore 3300:

- Click the actions link at the top of the configuration utility to display the Actions dialog, and then select Power Off option.
- SSH, or use a console connection to LiveWire and use the 'shutdown' command from the command prompt (*admin@livewire*):

```
shutdown -h now
```

Note You can also use the iDRAC interface to shutdown and start LiveWire PowerCore 3300. See the LiveWire User Guide.

Attaching the front bezel

To attach the front bezel on the LiveWire PowerCore 3300:

- Attach the front bezel by inserting the locking hooks into the front chassis of LiveWire PowerCore 3300. The bezel should be centered between the two black tabs on the left and right of the chassis.



Contacting LiveAction support

Please contact LiveAction support at <https://www.liveaction.com/support/technical-support/> if you have any questions about the installation and use of LiveWire.

An RMA (Return Material Authorization) number must be obtained from LiveAction before returning hardware. Please contact LiveAction technical support at <https://www.liveaction.com/support/technical-support/> for instructions.